

Inspiration SILVAN

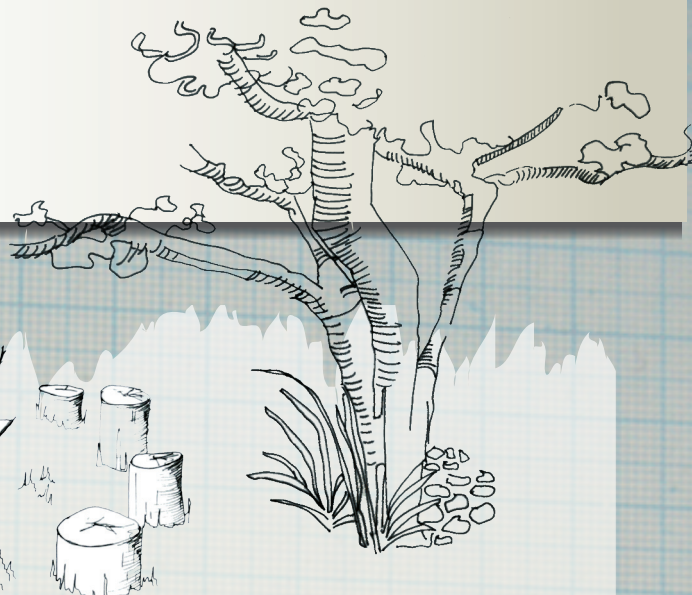

Materialeliste: havebænk

UNDERDEL

IMPREGNERET STOLPE 75x75 mm (A)

2 STK 80 cm

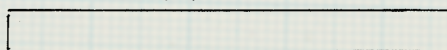

LÆGTE 38x57 mm

2 STK 81 cm

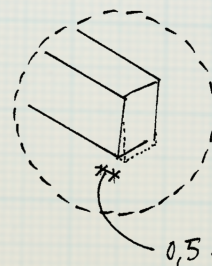
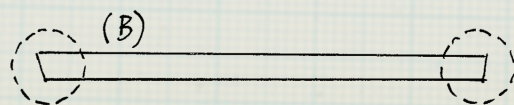

0,5 cm

SADE (C)

TERRASSEBRÆDT 20x140 mm

6 STK à 70 cm

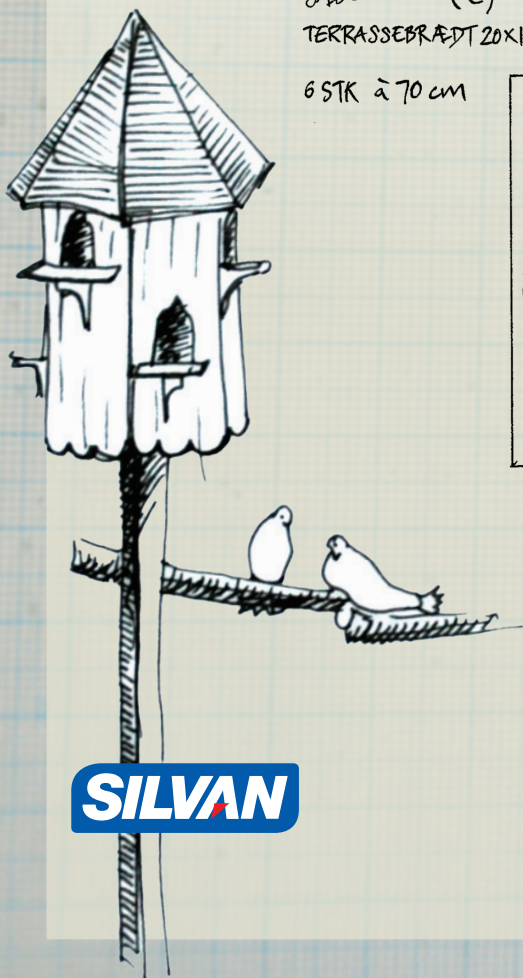
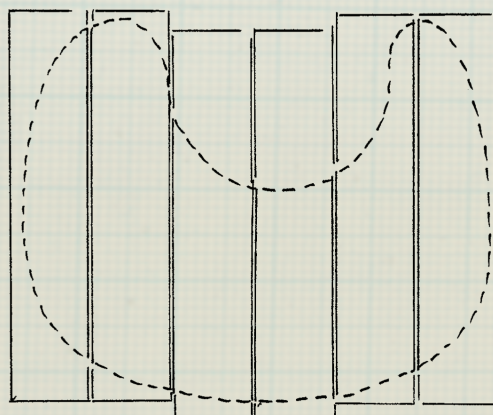

SILVAN

Inspiration SILVAN

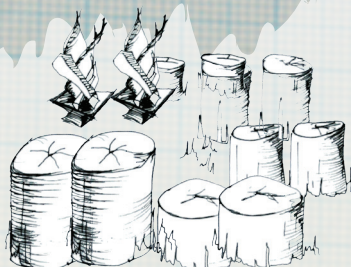
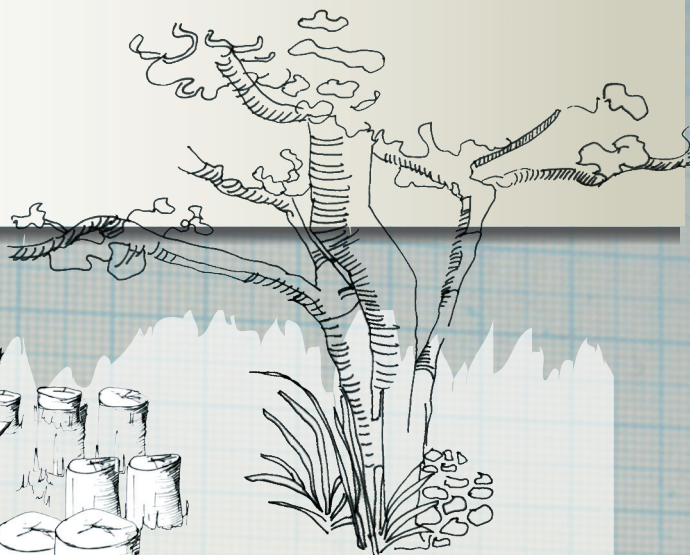

Materialer og værktøj: havebænk



SILVAN

Inspiration **SILVAN**

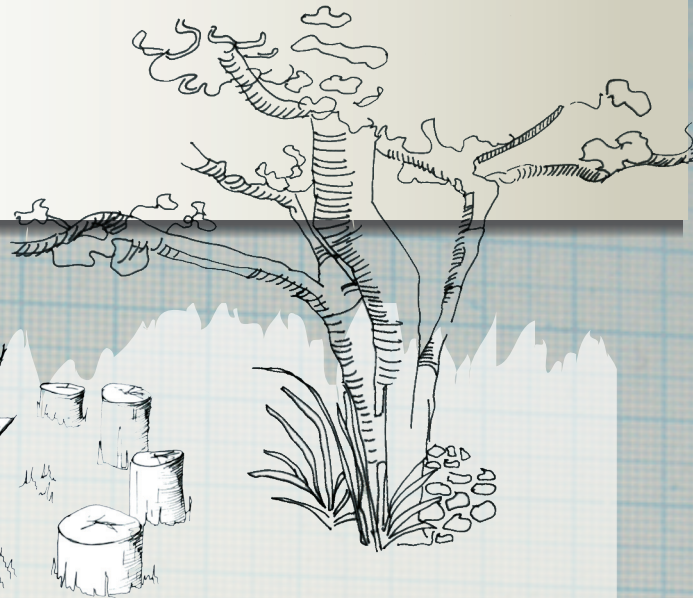

Teknisk tegning: havebænk

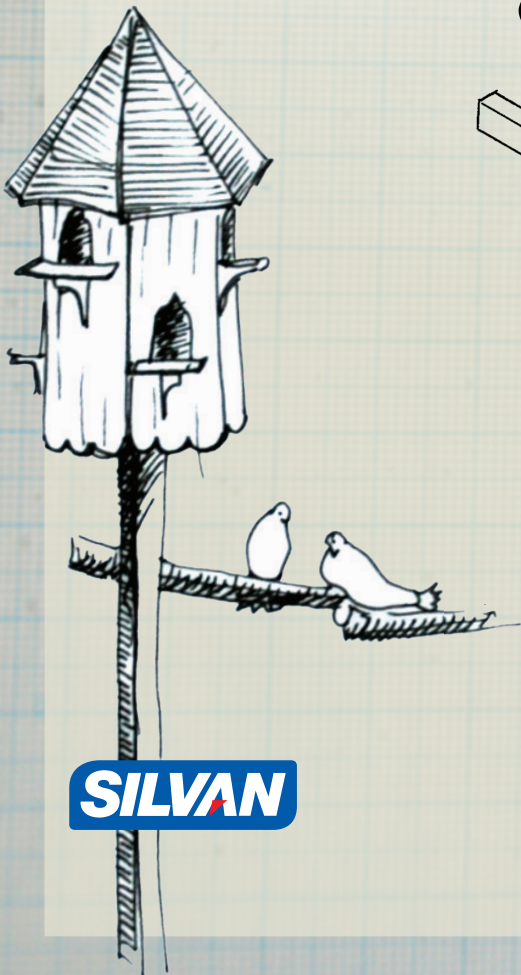
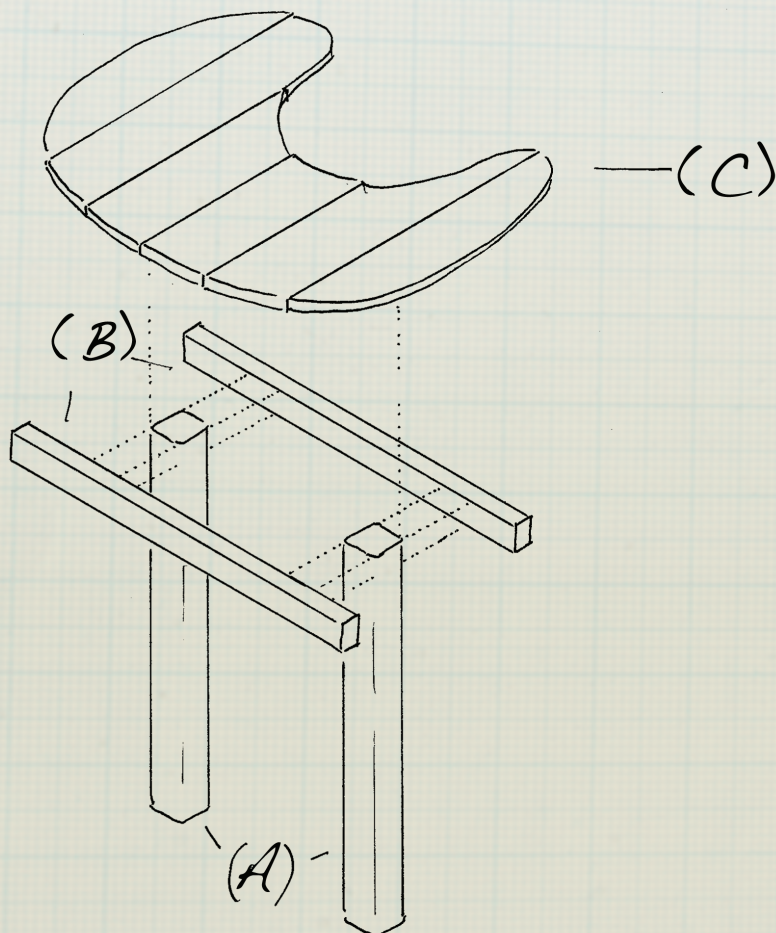

SILVAN



Inspiration **SILVAN**

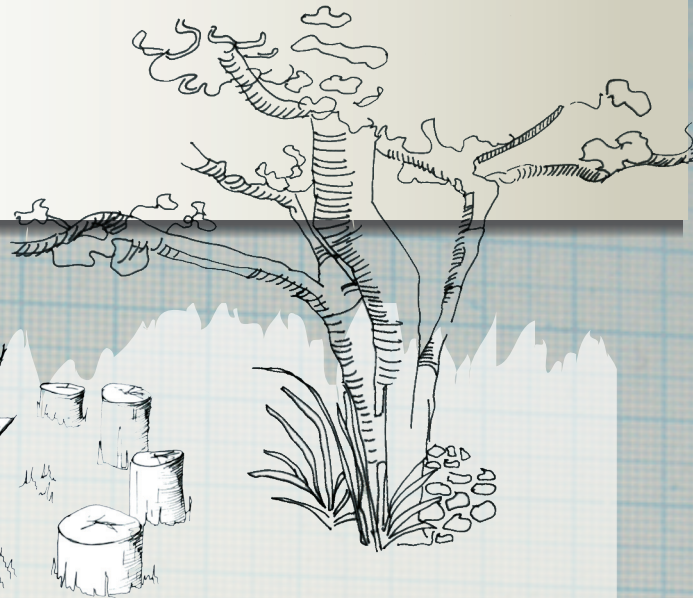

Teknisk tegning: havebæk

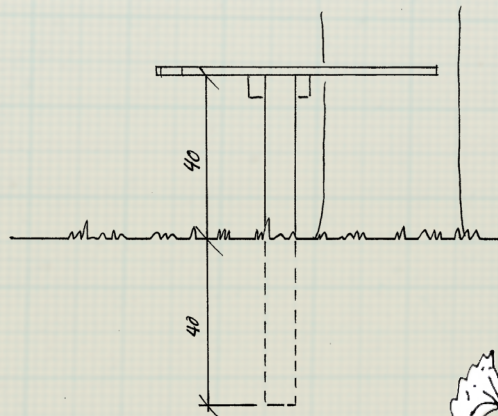
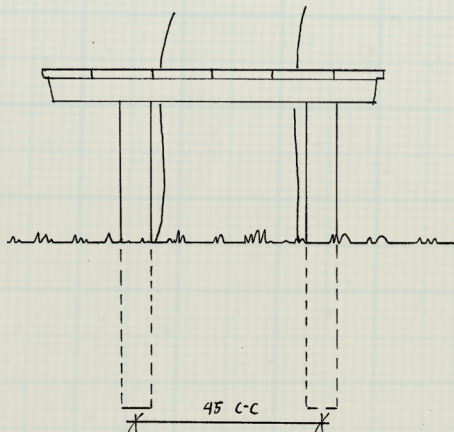
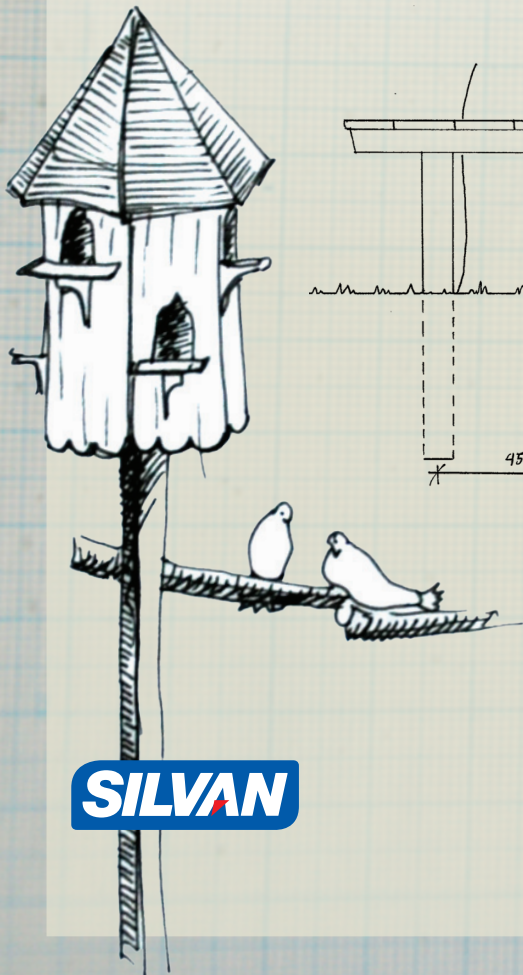
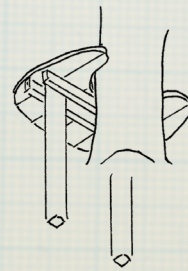
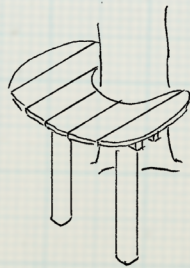

SILVAN

